

Wireless DIY Access Control

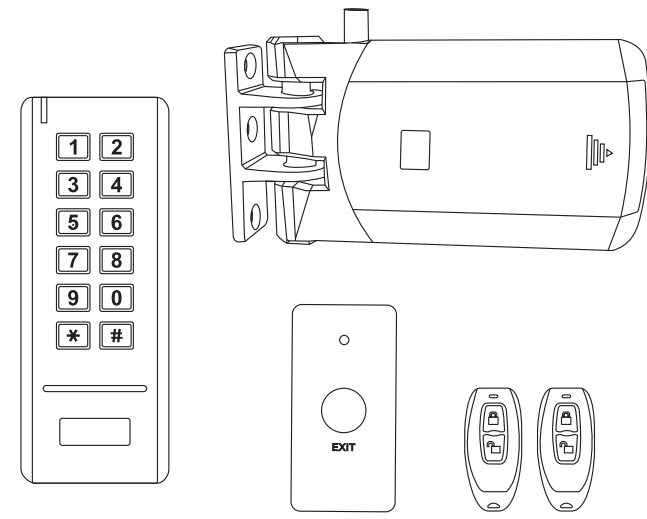

User Manual

INTRODUCTION

This is a wireless smart access control for home and office use. It consists of a Wireless Keypad, a Wireless Lock, a Wireless Exit Button and two Remote Transmitters. Super strong 3M stickers provide a simple way for installation. 433MHz Rolling Code of encryption algorithm and the split design guarantee higher-secure. The Keypad can store 500 PIN/card users. Because of ultra low power consumption, the Keypad, Exit Button and Remote Transmitters can work as long as one year(bases on 30 times/day), Wireless Lock can work 6 months. It will remind people to replace batteries intelligently if low battery.

Features:

- 500 PIN/card users
- 4-8 digits PIN, 125 KHz EM Card
- With two Remote Transmitters
- 433MHz Rolling Code technology
- Communication distance: 50m Max
- Ultra low power consumption

Specifications:

User Capacity	500
PIN Length	4-8 Digits
Card Type	125KHz EM Card
Operating Voltage	3 units of AAA batteries 2 units of AA batteries
Wireless Keypad	2 units of AA batteries
Wireless Lock	1 unit of 2032 Lithium battery
Wireless Exit Button	1 unit of 2032 Lithium battery
Remote Transmitter	
Idle Current	All items < 10uA
Working Current	< 50mA
Wireless Keypad	< 42mA
Wireless Lock	< 3mA
Wireless Exit Button	< 3mA
Remote Transmitter	< 3mA
Communication Frequency	433MHz
Communication Distance	50m Maximum
Operating Temperature	-40°C ~ +60°C (-40°F ~ +140°F)
Wireless Keypad	-20°C ~ +60°C (-4°F ~ +140°F)
Wireless Lock	
Operating Humidity	0% ~ 86%RH
Physical	
Wireless Lock	Zinc-Alloy + ABS Shell
Others	ABS Shell

Dimensions	
Wireless Keypad	L135*W54*D19(mm)
Wireless Lock	L150*W95*D39(mm)
Wireless Exit Button	L83*W40*D16(mm)
Remote Transmitter	L62*W30*D11.5(mm)
Unit Weight	
Wireless Keypad	90g
Wireless Lock	800g
Wireless Exit Button	30g
Remote Transmitter	25g/pc

Major Parts

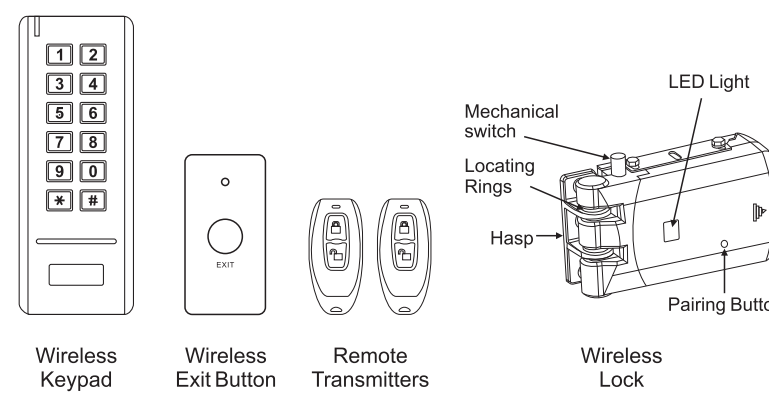

INSTALLATION

Method 1: Stick by 3M stickers

The device packed with 3M double-side stickers, can easily stick the Wireless Keypad and Wireless Exit Button and Wireless Lock on smooth surface (We used high-quality 3M stickers, the stickiness will be the best after sticking in 24 hours).

Below introduction for how to install Wireless Lock intensively:

Attentions of installing the Hasp

Confirm the direction and position of Hasp, meanwhile, make sure the Hasp align the doorframe. (So please make sure the direction of Hasp is fit for main body of lock before installation.)

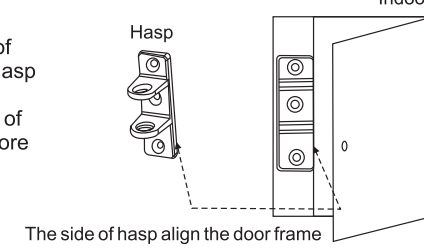

Installing the Hasp

Put the Locating Rings into Hasp, and stick the 3M sticker at the back side of Hasp (You can screw the Hasp on the Reinforcing Plate if needed, then stick 3M sticker at the back of plate. It can increase the stick area to make the Hasp stronger).

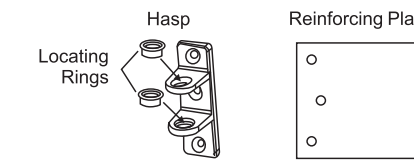

Installing the main body of lock

Fix the main body of lock and the Fixed Plate by M5*6 hex screws in the packaging, and stick the 3M sticker on the back of Fixed Plate.

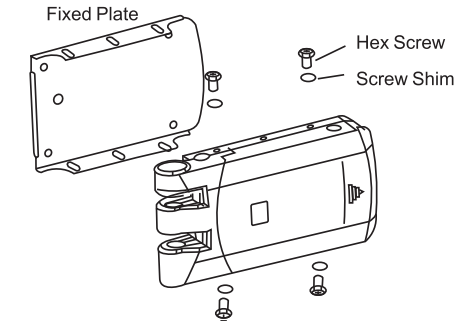

Combining the lock

Press the Mechanical Switch on the main body of lock to open the lock mechanically, and match the Hasp. Make sure it can be combined with Hasp perfectly, then stick the mail body of lock on the door.

Note: Mechanical Switch, it is used for installation and equipment trouble, please don't press it often in the normal condition.

When press the Mechanical Switch, the lock will be unlock all the time until open the door one time by valid card, or valid PIN, or press the Exit button, or unlock button on Remote Transmitter.

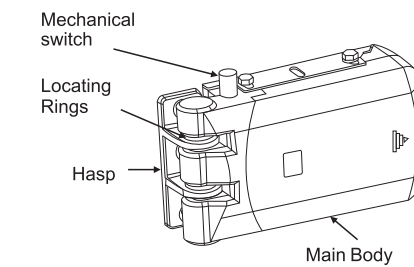

Method 2: Install by screws

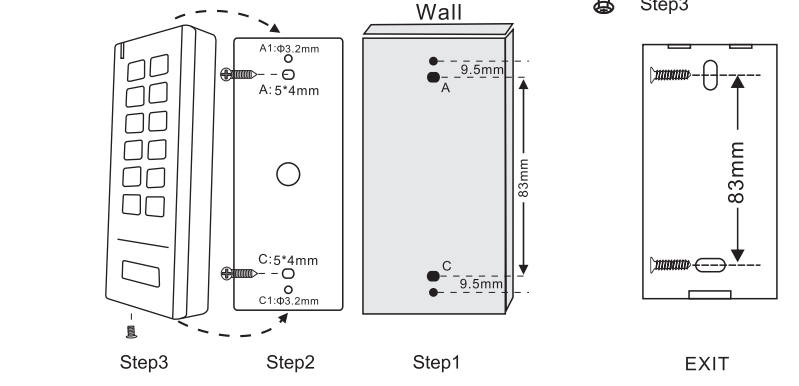
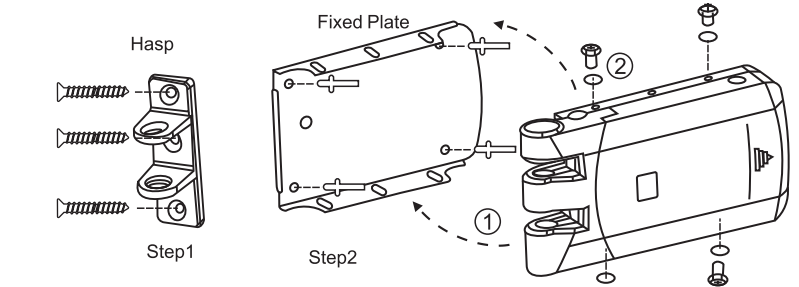

PROGRAMMING

Enter and Exit Program Mode

Programming Step	Keystroke Combination
1. Enter Program Mode	* (Master Code) # (Factory default is 123456)
2. Exit	*

Set Master Code

Please do remember your Master Code because the Master Code can't be reset if forget it.

Programming Step	Keystroke Combination
1. Enter Program Mode	* (Master Code) #
2. Update Master Code	0 (New Master Code) # (Repeat New Master Code) # Master code is any 6 digits
3. Exit	*

Simplified Instruction

Function description	Operation
Enter the Program Mode	* (Master Code) # (123456 is the factory default master code)
Change the Master Code IMPORTANT NOTE: Please remember the New Master Code as it can't be reset to default if forgotten	0 (New Code) # (Repeat New Code) # (code: 6 digits)
Add PIN User	1 (User ID) # (PIN) # (Repeat PIN) #
Add Card User	1 (Read Card)
Delete User	2 (User ID) # 2 (Read Card)
Exit from the Program Mode	*
How to release the door	
PIN Access	PIN #
Card Access	# (Read Card)
By Remote Transmitter	Press []
Lock Immediately	
By Keypad	Press "0 #"
By Remote Transmitter	Press []

Add Users PIN(s)

User ID: 0~499; PIN length: 4~8 digits

Programming Step	Keystroke Combination
1. Enter Program Mode	* (Master Code) #
2. Add PIN	1 (User ID) # (PIN) # (Repeat PIN) # The users can be added continuously
3. Exit	*

Add Users Card(s)

User ID: 0~499; Card type: 125 KHz EM Card

Programming Step	Keystroke Combination
1. Enter Program Mode	* (Master Code) #
2. Add Card: Using Auto ID (Allows to assign Card to next available User ID number) OR 2. Add Card: Select Specific ID (Allows Master to define a Specific User ID to associate the card)	1 (Read Card) # The cards can be added continuously 1 (User ID) # (Read Card) #
3. Exit	*

Change PIN

Note: Below is done outside programming mode, users can undertake this themselves

Programming Step	Keystroke Combination
1. Change PIN: By Card (There will be auto allocate PIN (8888) to cards when adding) OR 1. Change PIN: By User ID	* (Read Card) (Old PIN) # (New PIN) # (Repeat New PIN) # * (User ID) # (Old PIN) # (New PIN) # (Repeat New PIN) #
2. Exit	Exit automatically

Delete Users

Programming Step	Keystroke Combination
1. Enter Program Mode	* (Master Code) #
2. Delete user OR 2. Delete Card OR 2. Delete all users	2 (User ID) # The users can be deleted continuously. 2 (Read Card) # 2 (Master Code) #
3. Exit	*

Set Access Mode

Programming Step	Keystroke Combination
1. Enter Program Mode	* (Master Code) #
2. PIN Access OR 2. PIN + Card Access	3 0 # 3 1 #
2. PIN or Card Access	3 2 # (factory default)
3. Exit	*

Set Safety Mode

In safety mode, it can be set to deny access for 10 minutes after 10 failed PIN/card attempts in 10 minutes (Factory default is OFF).

Programming Step	Keystroke Combination
1. Enter Program Mode	* (Master Code) #
2. Strike-Out OFF OR 2. Strike-Out ON	6 0 # (factory default) 6 1 #
3. Exit	*

Set Buzzer

Programming Step	Keystroke Combination
1. Enter Program Mode	* (Master Code) #
2. Buzzer OFF OR 2. Buzzer ON	7 0 # 7 1 # (factory default)
3. Exit	*

OTHERS

Users Operation

Programming Step	Keystroke Combination
PIN User Access	(PIN) #
Card User Access	# (Read Card)
PIN + Card User Access	# (Read Card) (PIN) #
By Remote Transmitter	Press []

Lock Immediately

The Wireless Lock will be locked automatically around 8-10 seconds after we open it. If we want to lock it faster, please press "0 #" on the Keypad, or press [] on the Remote Transmitter, it will lock immediately.

Pair Wireless Keypad / Wireless Exit Button / Remote Transmitter with Wireless Lock

(They are already paired when out of factory, if no problem, the users do not need to do this operation in using.)

Note: 1. The Wireless Lock can pair 16 parts (Keypad + Remote Transmitter + Exit Button) maximum.
2. When pairing, all parts must be paired, then exit pairing mode. If need adding one more part, you still need to pair all parts again.

Step 1: Enter pairing mode

Open the battery cover of Wireless Lock, press the small round button left of battery with a slender rod, hold it for 2 seconds until hearing one long beep and two beeps, that means in the pairing status.

Step 2: Pairing Wireless Keypad

Press the button "0 #" on the keypad, hold it for 2 seconds until hearing two beeps from Lock, that means pairing successfully.

Step 3: Pairing Wireless Exit Button

Press the exit button, hold it until hearing three beeps from Lock, that means pairing successfully.

Step 4: Pairing Remote Transmitter

Press any button on the Remote Transmitter, hold it until hearing one beep from Lock, that means pairing successfully.

Step 5: Exit pairing mode

After pairing all parts, press the small round button in the Wireless Lock again, hold it until hearing one beep, that means exit pairing successfully.

Packing List

Name	Quantity
Packaging box	1pc
Wireless Keypad	1pc
Wireless Lock	1pc
Wireless Exit Button	1pc
Remote Transmitters	2pcs
Manual	1pc
Screw Driver	1pc
Wall Fixing Plus	4pcs
Self Tapping Screws	4pcs
Accessories of Wireless Lock	4sets
3M Stickers	4pcs

Sound and Light Indication

Device	Operation Status	Red LED	Green LED	Buzzer
Keypad	Standby	--	--	--
	Enter into program mode	Shines per 1.5 seconds	--	One beep
	Unlock the lock	--	ON for 3 seconds	One beep
	Press key	--	--	One beep
	Wrong operation	--	--	Three beeps
	Invalid PIN/card	--	--	Three beeps
	Exit from the program mode	--	ON for 1 seconds	One beep
Lock	Low battery reminding	Orange LED ON		Three beeps when press any button
	Pairing	ON	--	One long beep
	Unlock the lock	ON for 1 second	--	Two beeps
	Lock	ON for 1 second	--	One beep
	Low battery reminding	LED shining, and beeps (Note: The lock will open automatically when the battery is too low or run out, please change the battery IN TIME!)		
Exit Button & Remote Transmitter	Press button	LED ON for 1 second		
	Low battery reminding	When the LED is dim, please change the battery		